

# GP Batteries

## Product Specification

Model no.: D451

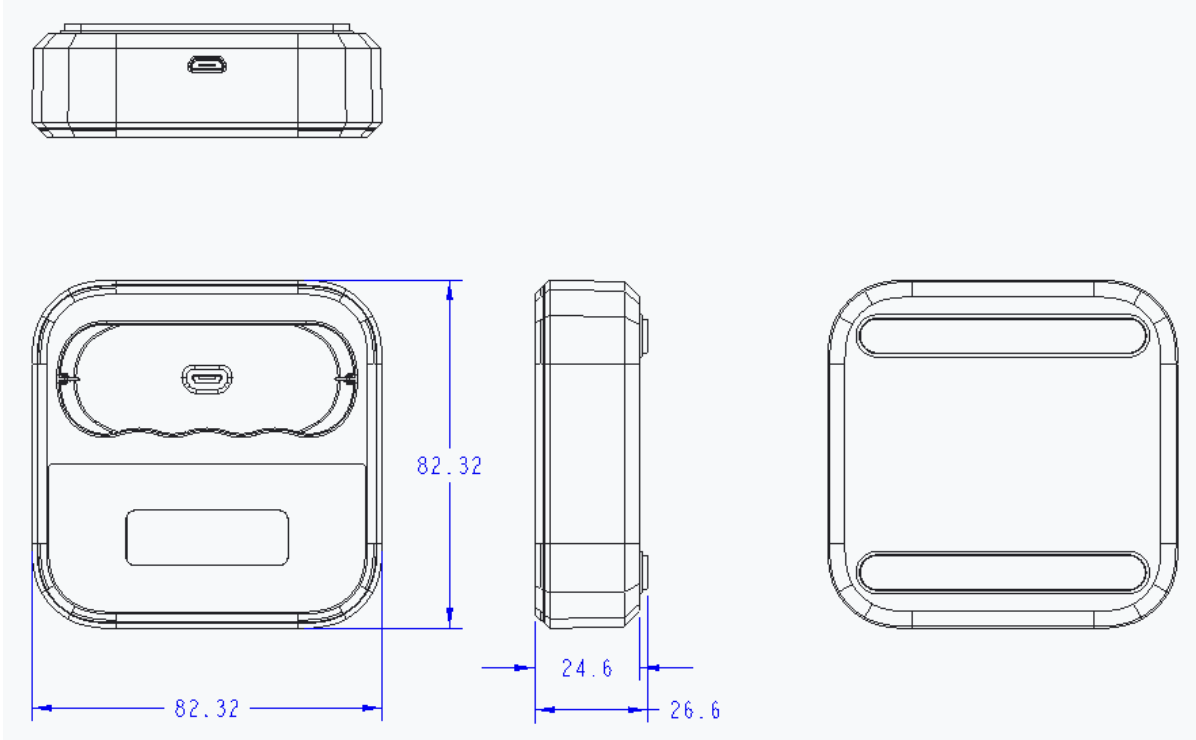

Product Name	:	USB 4-Slot Charging Dock <b>D451</b>
Input	:	DC5V 2.1A
Applicable Charger	:	1 pcs of USB 4-slot Charger of B421, M451 or P461
Charging Time	:	Same charging time of B421, M451 and P461
Operation Temperature	:	0°C to 35°C
Dimensions	:	82 (L) x 82 (W) x 27 (H) mm
Weight	:	71.5 g (approx.)
Certification	:	CE, FCC, Rohs
Warranty Period	:	12 months from ex-factory date

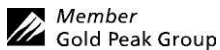



Manufacturer reserves the right to alter or amend the design, model and specification without prior notice.

# GP Batteries

## Product Specification

Model no.: D451

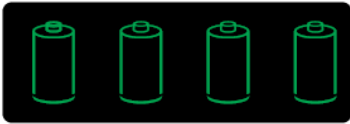
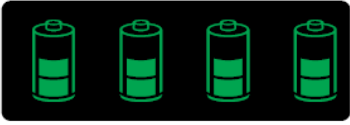
LCD Indication :

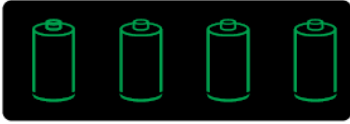
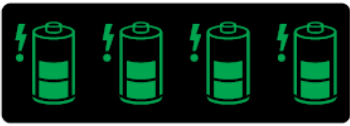
CONDITION	SCREEN DESCRIPTION	LCD STATES
Power on and no battery inserted	4 Batteries icon turn on	
Charging in progress	Corresponding battery power block flashing	
When charging is finished and then switch to trickle charge	Corresponding battery all power block invariability	
Bad/ Primary battery inserted	Corresponding battery icon flashing	
Ageing battery	Corresponding warning icon turn on and battery power block flashing	

 Member  
Gold Peak Group

Manufacturer reserves the right to alter or amend the design, model and specification without prior notice.